



GENERAL ROPE

WUXI METALLINK

Contents

3 6×7-FC
6×7-WSC
6×7-IWRC

5 6×19M-FC
6×19M-WSC
6×19M-IWRC

7 6×37M-FC
6×37M-WSC
6×37M-IWRC

9 6×19S-FC
6×19S-IWRC

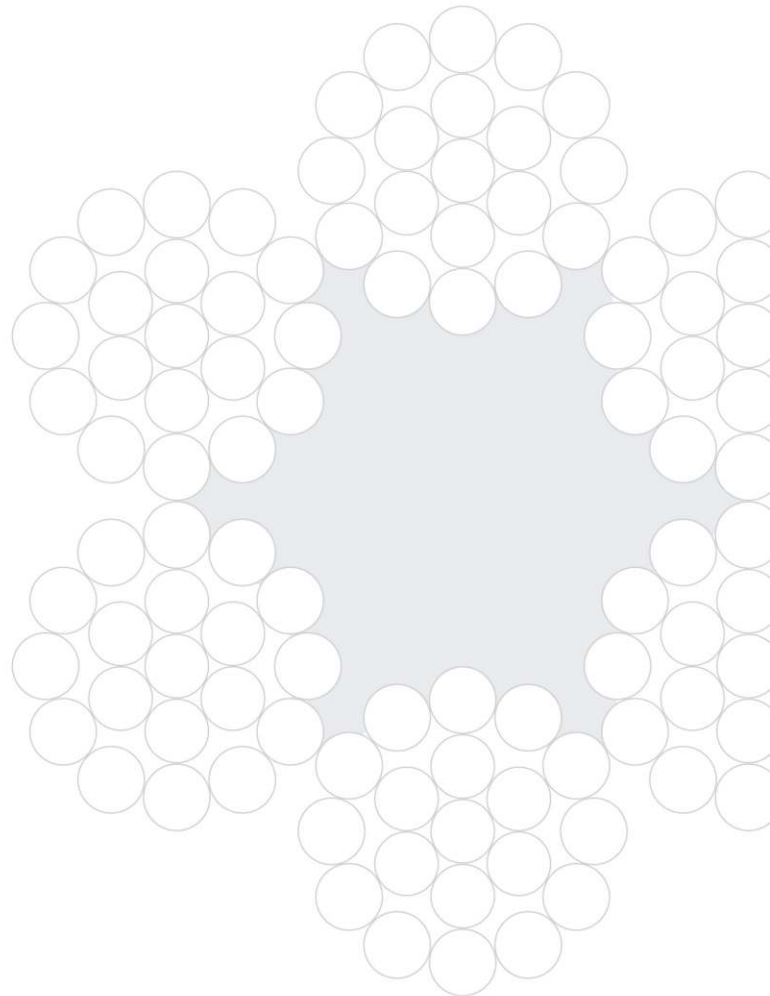

Rope for general purposes

Round strand

Application

General purposes

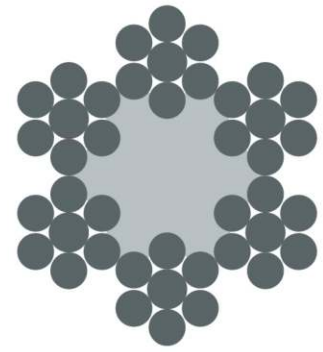

6×7-FC

Rope ø	Approx. length mass	MBL (1570)	MBL (1770)	MBL (1960)
mm	kg/100m	kN	kN	kN
2	1.40	2.08	2.35	2.60
3	3.16	4.69	5.29	5.86
4	5.62	8.34	9.40	10.4
5	8.78	13.0	14.7	16.3
6	12.6	18.8	21.2	23.4
7	17.2	25.5	28.8	31.9
8	22.5	33.4	37.6	41.6
9	28.4	42.2	47.6	52.7
10	35.1	52.1	58.8	65.1
11	42.5	63.1	71.1	78.7
12	50.5	75.1	84.6	93.7
13	59.3	88.1	99.3	110
14	68.8	102	115	128
16	89.9	133	150	167
18	114	169	190	211
20	140	208	235	260
22	170	252	284	315
24	202	300	338	375
26	237	352	397	440
28	275	409	461	510
30	316	469	529	586
32	359	534	602	666
36	455	676	762	843
40	562	834	940	1040

* Standard GB/T 20118, ISO 2408 is available upon request

Rope for general purposes

Round strand

Application

General purposes

Rope \varnothing	Approx. length mass	MBL (1570)	MBL (1770)	MBL (1960)
mm	kg/100m	kN	kN	kN
2	1.58	2.44	2.75	3.04
3	3.56	5.48	6.18	6.84
4	6.34	9.75	11.0	12.2
5	9.90	15.2	17.2	19.0
6	14.3	21.9	24.7	27.4
7	19.4	29.8	33.7	37.3
8	24.8	36.1	40.7	45.0
9	31.3	45.7	51.5	57.0
10	38.7	56.4	63.5	70.4
11	46.8	68.2	76.9	85.1
12	55.7	81.2	91.5	101
13	65.4	95.3	107	119
14	75.9	110	125	138
16	99.1	144	163	180
18	125	183	206	228
20	155	225	254	281
22	187	273	308	341
24	223	325	366	405
26	262	381	430	476
28	303	442	498	552
30	348	507	572	633
32	396	577	651	721
36	502	730	824	912
40	619	902	1020	1130

* Standard GB/T 20118, ISO 2408 is available upon request

* WSC for diameter ≤ 7 mm



6x7-WSC

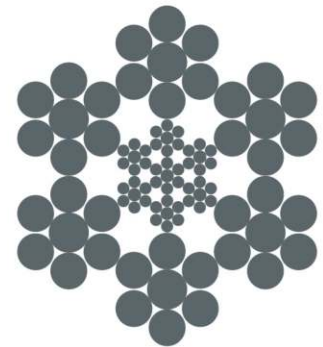

6x7-IWRC

Rope for general purposes

Round strand

Application

General purposes

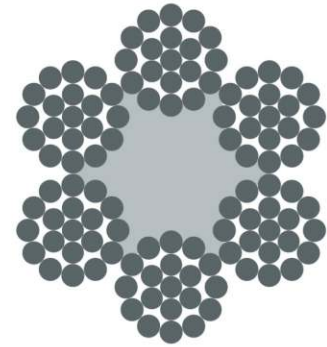

6×19M-FC

Rope ø	Approx. length mass	MBL (1570)	MBL (1770)	MBL (1960)
mm	kg/100m	kN	kN	kN
3	3.16	4.34	4.89	5.42
4	5.62	7.71	8.69	9.63
5	8.78	12.0	13.6	15.0
6	12.6	17.4	19.6	21.7
7	17.2	23.6	26.6	29.5
8	22.5	30.8	34.8	38.5
9	28.4	39.0	44.0	48.7
10	35.1	48.2	54.3	60.2
11	42.5	58.3	65.8	72.8
12	50.5	69.4	78.2	86.6
13	59.3	81.5	91.8	102
14	68.8	94.5	107	118
16	89.9	123	139	154
18	114	156	176	195
20	140	193	217	241
22	170	233	263	291
24	202	278	313	347
26	237	326	367	407
28	275	378	426	472
30	316	434	489	542
32	359	494	556	616
36	455	625	704	780
40	562	771	869	963

* Standard GB/T 20118, ISO 2408 is available upon request

Rope for general purposes

Round strand

Application

General purposes

Rope \varnothing	Approx. length mass	MBL (1570)	MBL (1770)	MBL (1960)
mm	kg/100m	kN	kN	kN
3	3.43	5.12	5.77	6.39
4	6.10	9.09	10.3	11.4
5	9.53	14.2	16.0	17.7
6	13.7	20.5	23.1	25.5
7	18.7	27.8	31.4	34.8
8	25.6	33.4	37.6	41.6
9	32.4	42.2	47.6	52.7
10	40.0	52.1	58.8	65.1
11	48.4	63.1	71.1	78.7
12	57.6	75.1	84.6	93.7
13	67.6	88.1	99.3	110
14	78.4	102	115	128
16	102	133	150	167
18	130	169	190	211
20	160	208	235	260
22	194	252	284	315
24	230	300	338	375
26	270	352	397	440
28	314	409	461	510
30	360	469	529	586
32	410	534	602	666
36	518	676	762	843
40	640	834	940	1040

* Standard GB/T 20118, ISO 2408 is available upon request

* WSC for diameter ≤ 7 mm

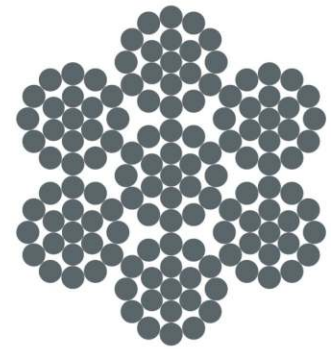

6×19M-WSC

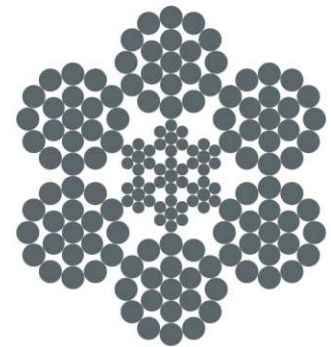

6×19M-IWRC

Rope for general purposes

Round strand

Application

General purposes

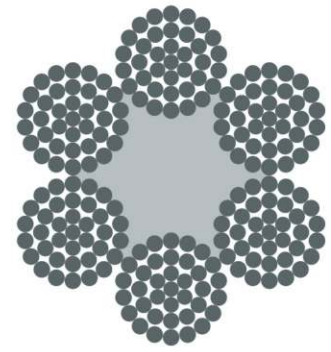

6×37M-FC

Rope ø	Approx. length mass	MBL (1570)	MBL (1770)	MBL (1960)
mm	kg/100m	kN	kN	kN
5	8.65	11.6	13.1	14.5
6	12.5	16.7	18.8	20.8
7	17.0	22.7	25.6	28.3
8	22.1	29.6	33.4	37.0
9	28.0	37.5	42.3	46.8
10	34.6	46.3	52.2	57.8
11	41.9	56.0	63.2	70.0
12	49.8	66.7	75.2	83.3
13	58.5	78.3	88.2	97.7
14	67.8	90.8	102	113
16	88.6	119	134	148
18	112	150	169	187
20	138	185	209	231
22	167	224	253	280
24	199	267	301	333
26	234	313	353	391
28	271	363	409	453
30	311	417	470	520
32	354	474	535	592
36	448	600	677	749
40	554	741	835	925

* Standard GB/T 20118, ISO 2408 is available upon request

Rope for general purposes

Round strand

Application

General purposes

Rope \varnothing	Approx. length mass	MBL (1570)	MBL (1770)	MBL (1960)
mm	kg/100m	kN	kN	kN
5	9.53	13.6	15.3	17.0
6	13.7	19.6	22.0	24.4
7	18.7	26.6	30.0	33.2
8	25.6	32.1	36.1	40.0
9	32.4	40.6	45.7	50.6
10	40.0	50.1	56.5	62.5
11	48.4	60.6	68.3	75.7
12	57.6	72.1	81.3	90.0
13	67.6	84.6	95.4	106
14	78.4	98.2	111	123
16	102	128	145	160
18	130	162	183	203
20	160	200	226	250
22	194	242	273	303
24	230	288	325	360
26	270	339	382	423
28	314	393	443	490
30	360	451	508	563
32	410	513	578	640
36	518	649	732	810
40	640	801	903	1000

* Standard GB/T 20118, ISO 2408 is available upon request

* WSC for diameter ≤ 7 mm

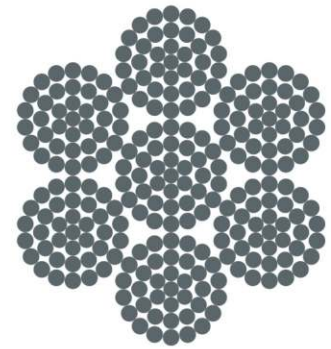

6x37M-WSC

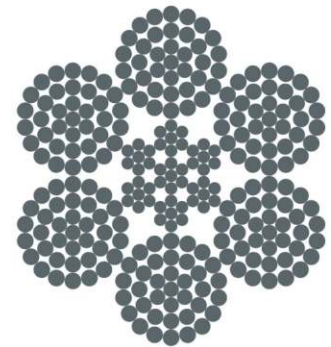

6x37M-IWRC

Rope for general purposes

Round strand

Application

General purposes and crane usage

Rope \varnothing	Approx. length mass	MBL (1770)	MBL (1960)	MBL (2160)
mm	kg/100m	kN	kN	kN
6	15.0	22.7	25.1	27.7
7	20.5	30.9	34.2	37.7
8	26.8	40.3	44.7	49.2
9	33.9	51.0	56.5	62.3
10	41.8	63.0	69.8	76.9
11	50.6	76.2	84.4	93.0
12	60.2	90.7	100	111
13	70.6	106	118	130
14	81.9	124	137	151
16	107	161	179	197
18	135	204	226	249
20	167	252	279	308
22	202	305	338	372
24	241	363	402	443
26	283	426	472	520
28	328	494	547	603
30	376	567	628	692
32	428	645	715	787
36	542	817	904	997
40	669	1010	1120	1230
44	809	1220	1350	1490
48	963	1450	1610	1770
52	1130	1700	1890	2080
56	1310	1980	2190	2410
60	1500	2270	2510	2770

* Standard GB/T 20118, ISO 2408 is available upon request

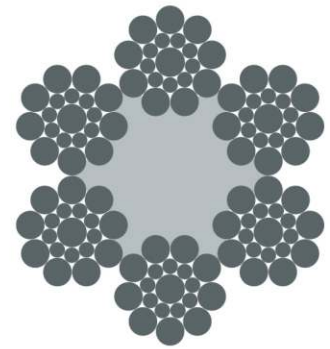

6×19S-FC

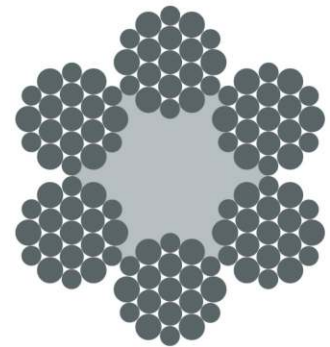

6×19W-FC

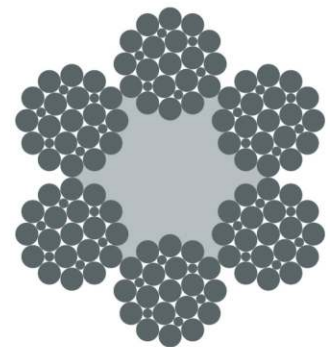

6×25F-FC

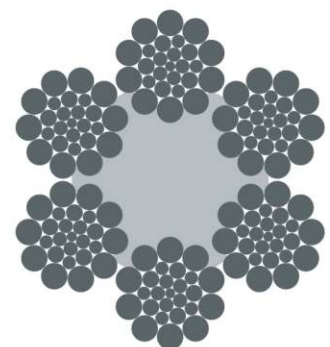

6×26WS-FC

Rope for general purposes

Round strand

Application

General purposes and crane usage

Rope \varnothing	Approx. length mass	MBL (1770)	MBL (1960)	MBL (2160)
mm	kg/100m	kN	kN	kN
6	15.0	22.7	25.1	27.7
7	20.5	30.9	34.2	37.7
8	26.8	40.3	44.7	49.2
9	33.9	51.0	56.5	62.3
10	41.8	63.0	69.8	76.9
11	50.6	76.2	84.4	93.0
12	60.2	90.7	100	111
13	70.6	106	118	130
14	81.9	124	137	151
16	107	161	179	197
18	135	204	226	249
20	167	252	279	308
22	202	305	338	372
24	241	363	402	443
26	283	426	472	520
28	328	494	547	603
30	376	567	628	692
32	428	645	715	787
36	542	817	904	997
40	669	1010	1120	1230
44	809	1220	1350	1490
48	963	1450	1610	1770
52	1130	1700	1890	2080
56	1310	1980	2190	2410
60	1500	2270	2510	2770

* Standard GB/T 20118, ISO 2408 is available upon request

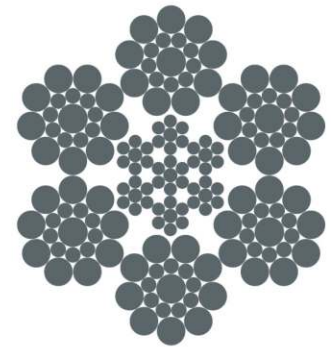

6×19S-IWRC

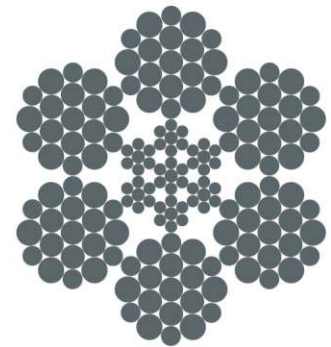

6×19W-IWRC

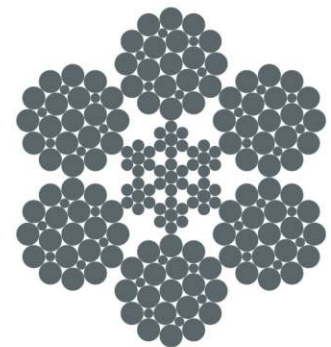

6×25F-IWRC

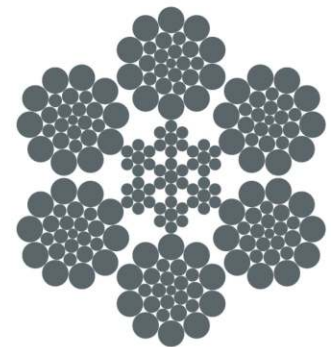

6×26WS-IWRC

Standardized rope designation

These symbols have to be used for the standardized rope designation

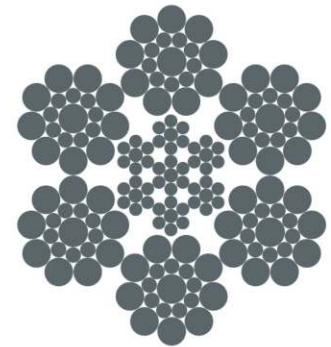

6×19S-IWRC

Example

10_6 × 19 S - IWRC 1770 U sZ GB/T 20118

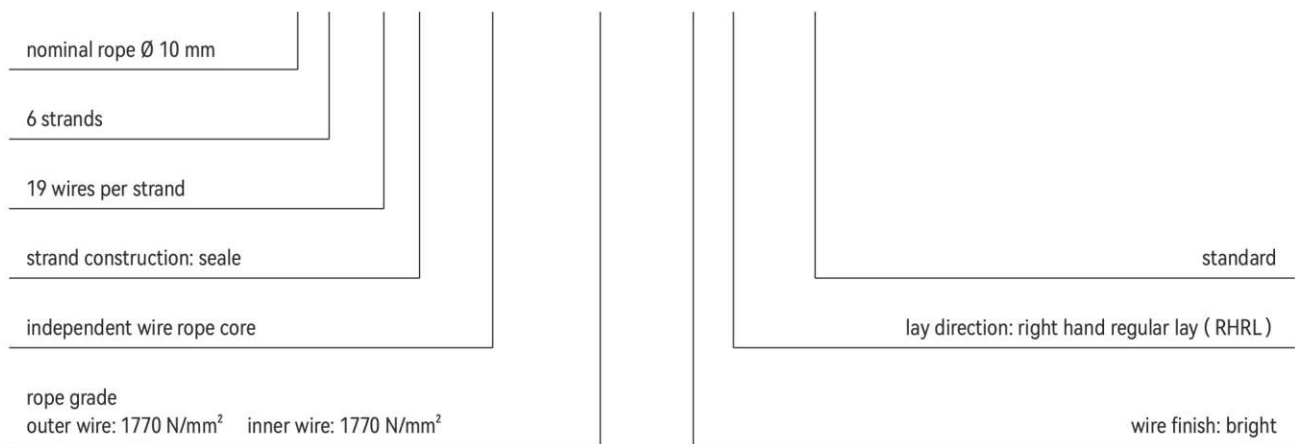

Strand construction

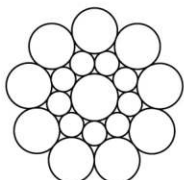

Seale

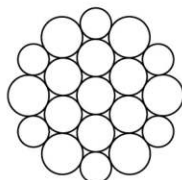

Warrington

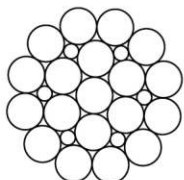

Filler

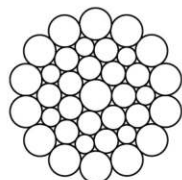

Warrington-Seale

Lay direction

sZ = right hand regular lay
zZ = right hand lang lay
zS = left hand regular lay
sS = left hand lang lay

Wire finish

U = bright, non-galvanized
B = quality B galvanized

Rope core type

NFC = natural fibre core
SFC = synthetic fiber core
WSC = wire strand core
IWRC = independant wire rope core
PWRC = parallel wire rope centre

Diameter measurement

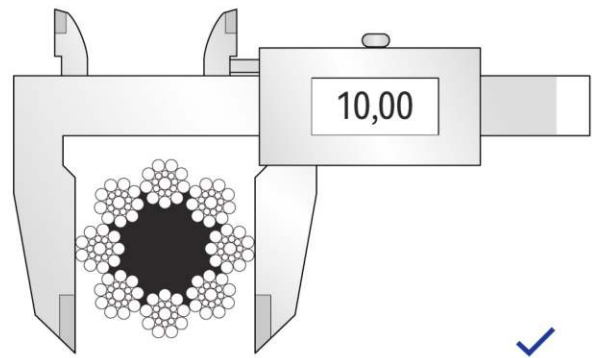
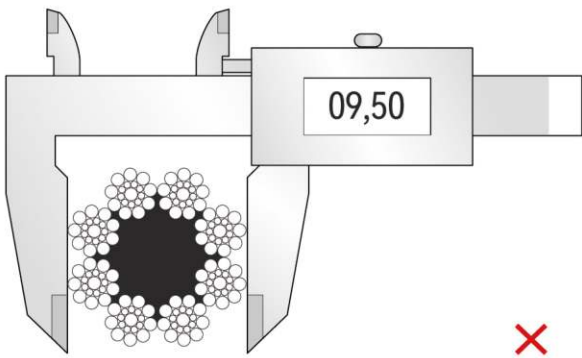

Carrying ropes

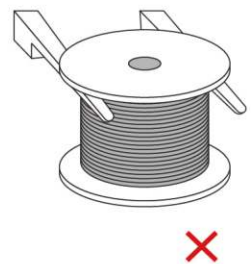
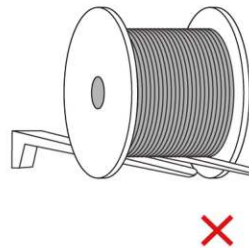
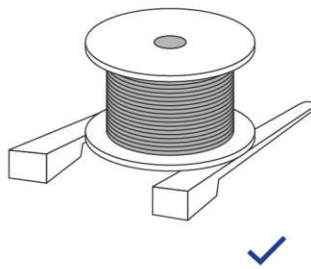
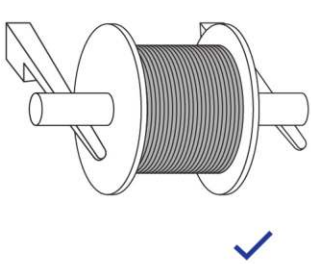

Unwinding ropes

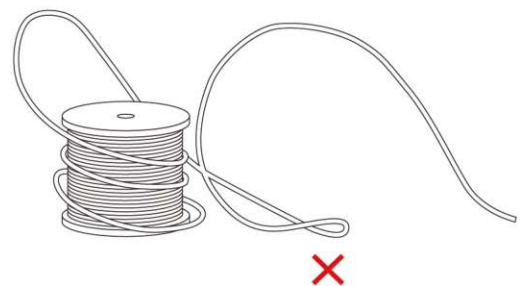
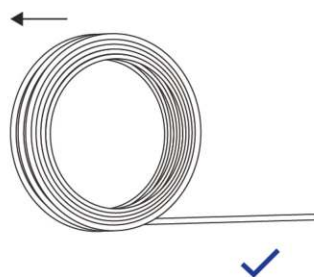
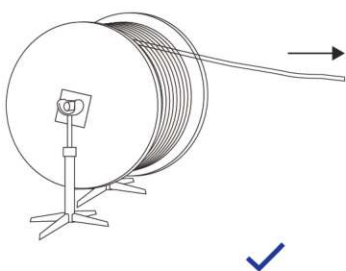



CONTACT US

WUXI METALLINK INTERNATIONAL TRADE CO.,LTD
JIANGSU METALLINK METAL PRODUCTS CO., LTD

ADD No.99,Huichang Road, Huishan District, Wuxi, Jiangsu, China
EMAIL neil@wxmetallink.com coco@wxmetallink.com
WEB www.wxmetallink.com